



DEM Jugend A 2017

am 05.02.2017

J Am+78



Draw Sheet

153 Barcin , Birkan
BTU , TSV 1865 Dachau

B

7

224

32 Bach , Marcel
BTU , Türk SV 1990 Bobingen

10

R

32 /B

20 **32** 18

241

132 /R

B

16

225

Johnson , Patrick **132**
BTU , Moo Duk Kwan e.V. Bad Windsheim

10

R

Vögeli , Urs Benedict **114**
TURP , Taekwondo Club Ingelheim e.V.

1. Marcel Bach (Türk SV 1990 Bobingen, BTU)
2. Patrick Johnson (Moo Duk Kwan e.V. Bad Windsheim, BTU)
3. Birkan Barcin (TSV 1865 Dachau, BTU)
3. Urs Benedict Vögeli (Taekwondo Club Ingelheim e.V., TURP)



DEM Jugend A 2017

am 05.02.2017
J Am-45



Draw Sheet

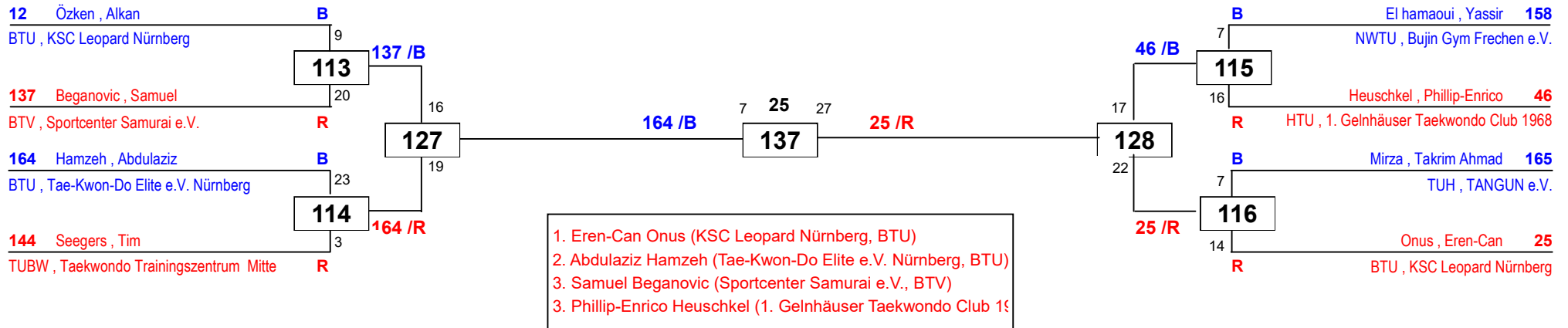



DEM Jugend A 2017

am 05.02.2017
J Am-48



Draw Sheet

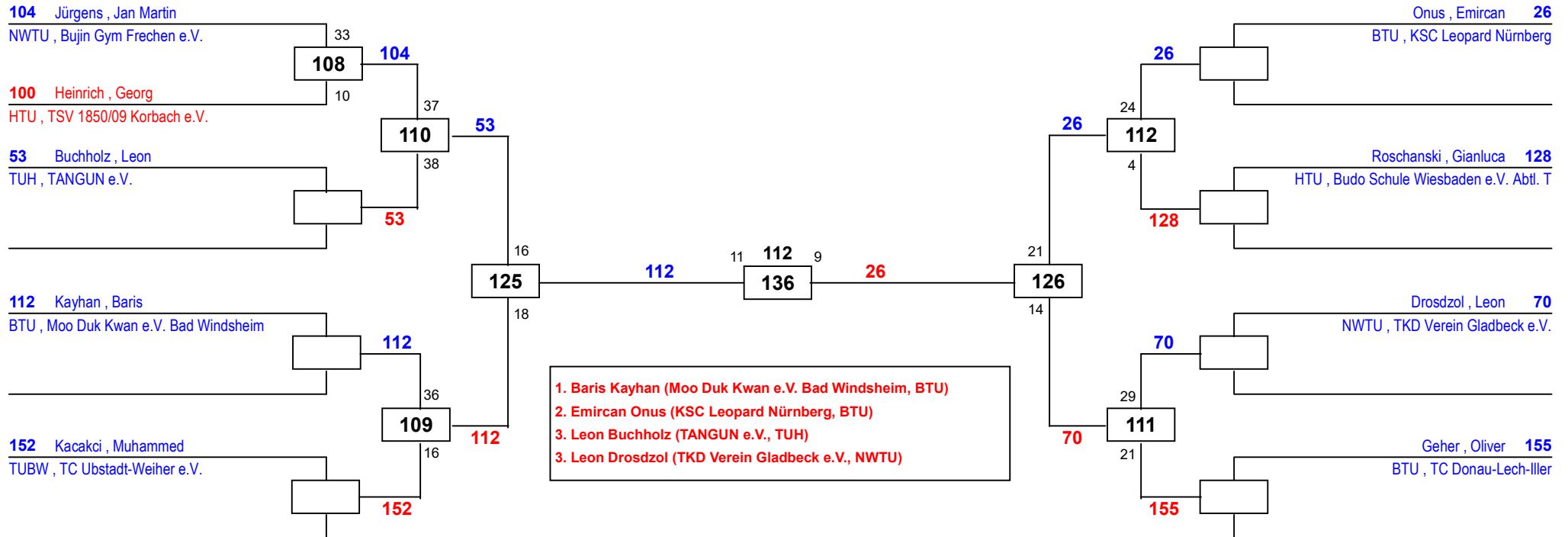



DEM Jugend A 2017

am 05.02.2017

J Am-51



Draw Sheet

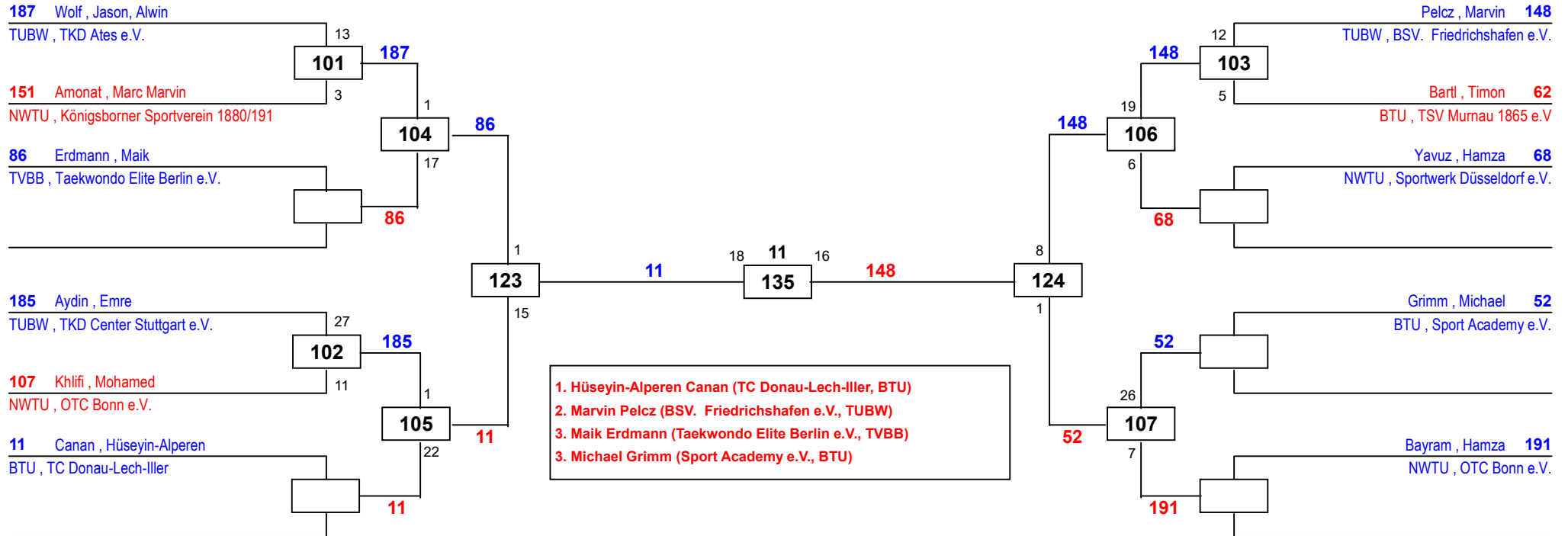

J Am-55 DEM Jugend A 2017

Ingolstadt

am 05.02.2017



Deutsche
Taekwondo
Union e.V.

Graf, Tobias 95

NWTU, Wuppertaler Tiger e.V.

Nitsas, Spiridon 175

BTU, TSV 1865 Dachau

Beganovic, Manuel 136

BTV, Sportcenter Samurai e.V.

Franzke, Marvin 40

NTU, BSV Jitae Stadthagen e.V. Abt. Tae

Radovic, Sasa 154

TUBW, TKD Verein Creti Tübingen e.V.

Malkoc, Cemal Can 57

TUH, TANGUN e.V.

Kiwitz, Benjamin 78

HTU, Taekwondo Schlüchtern e.V.

Andreopoulos, Antonios 157

NWTU, Sportwerk Düsseldorf e.V.

36 Karademir, Tolga
BTU, KSC Leopard Nürnberg

92 Yousufi, Mohammad
NWTU, Kangaroo Sports e.V.

33 Richter, Rico
TUT, TuS Osterburg 90 Weida e.V. Abt. T

47 Butschek, Pascal
TUSA, TKD Gemeinschaft Schönebeck e.V.

124 Mahler, Tom
TUS, Taifun Leipzig e.V.

138 Schulz, Leon
TUBW, TKD Ates e.V.

84 Bavosa, Timmy
BTU, TKD Özer

141 Ilias, Karabila
HTU, Han Dok Wiesbaden e.V.

81 Drebes, Ranye
TVBB, Taekwondo Elite Berlin e.V.

81 Drebes, Ranye
TVBB, Taekwondo Elite Berlin e.V.

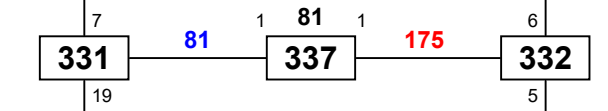
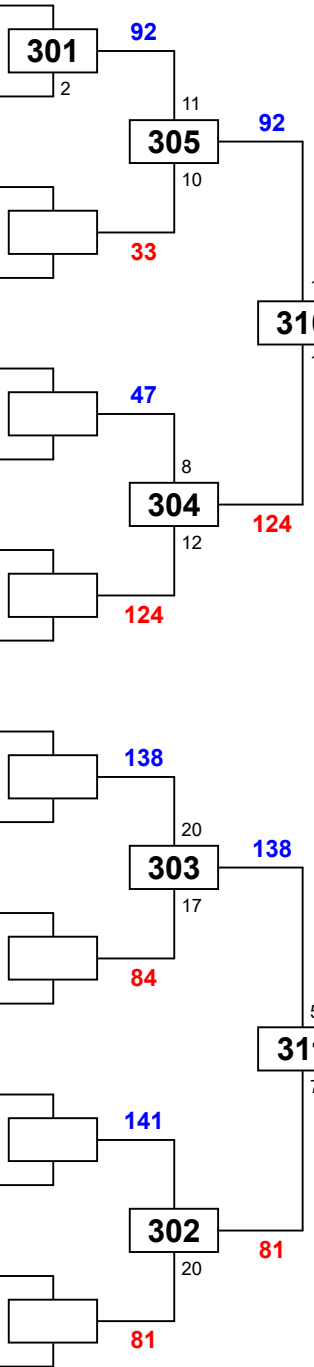

1. Ranye Drebes (Taekwondo Elite Berlin e.V., TVBB)
2. Spiridon Nitsas (TSV 1865 Dachau, BTU)
3. Antonios Andreopoulos (Sportwerk Düsseldorf e.V., NWTU)
3. Mohammad Yousufi (Kangaroo Sports e.V., NWTU)

Tournament Management by: DELTA SYSTEM HOUSE
www.deltapool.de

Copyright by Hamid Rahimi 1994 - 2016



DEM Jugend A 2017

am 05.02.2017

J Am-59



Draw Sheet

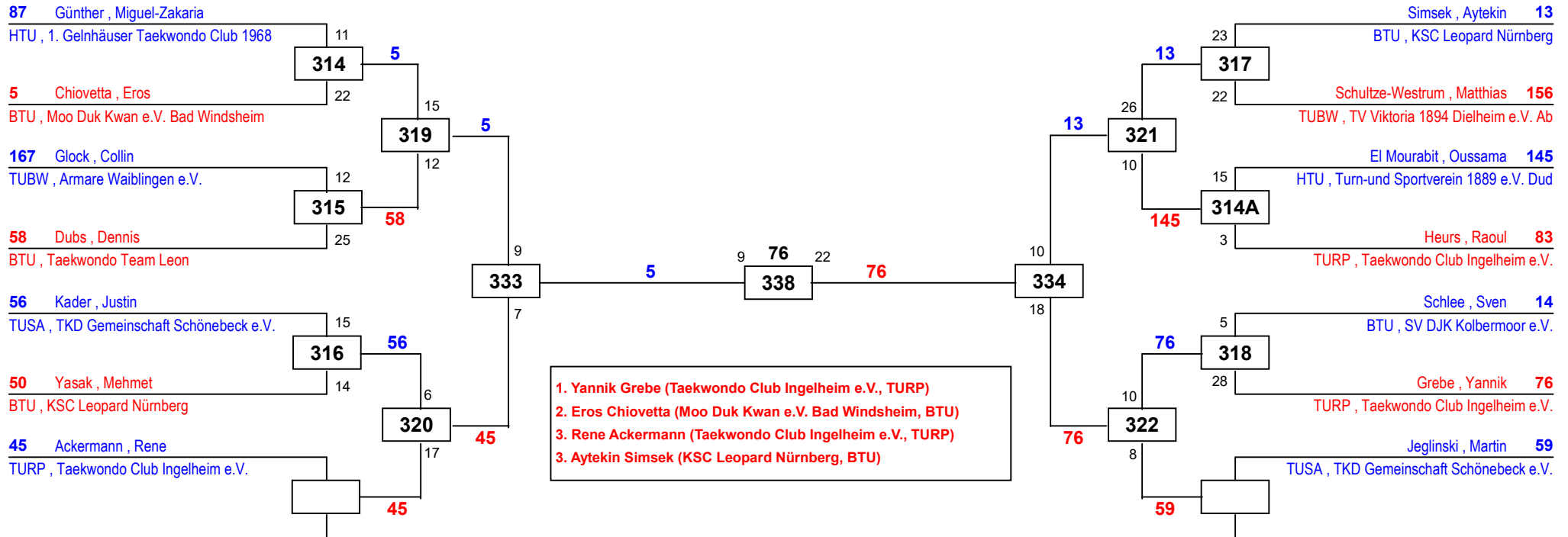



DEM Jugend A 2017

am 05.02.2017

J Am-63



Draw Sheet

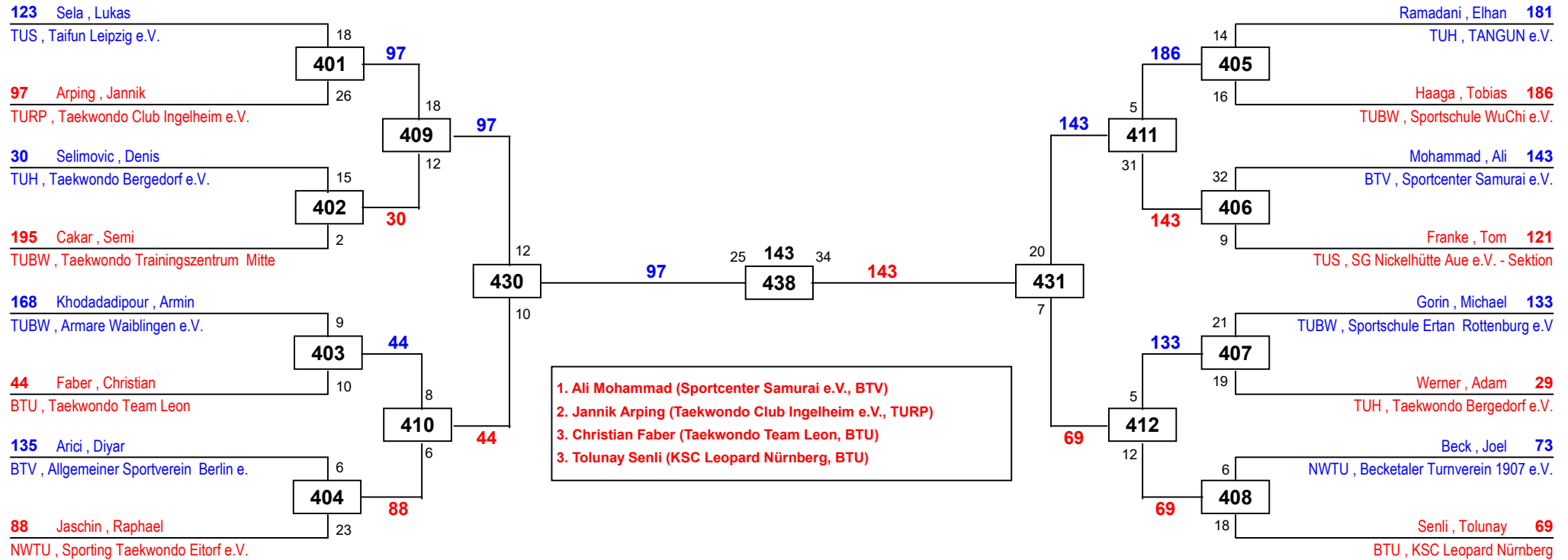



DEM Jugend A 2017

am 05.02.2017
J Am-68



Draw Sheet

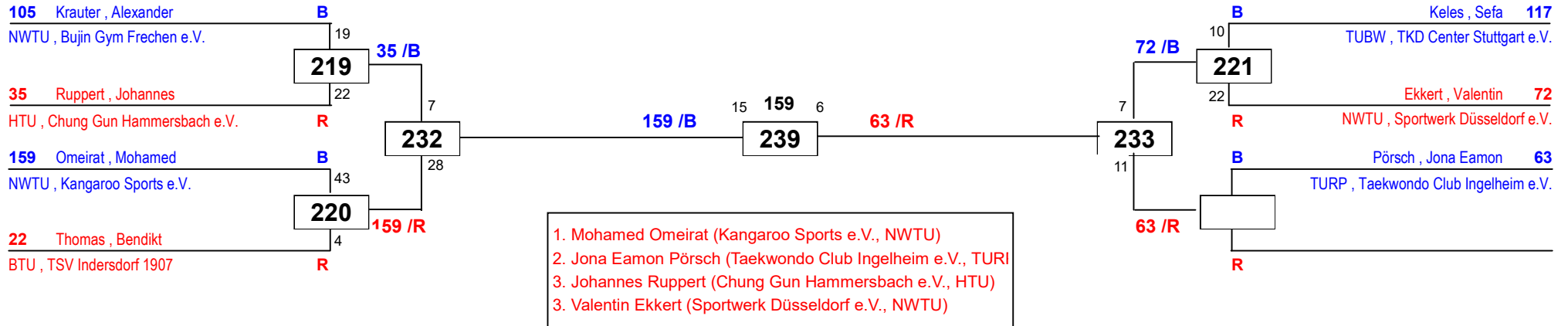



DEM Jugend A 2017

am 05.02.2017
J Am-73



Draw Sheet

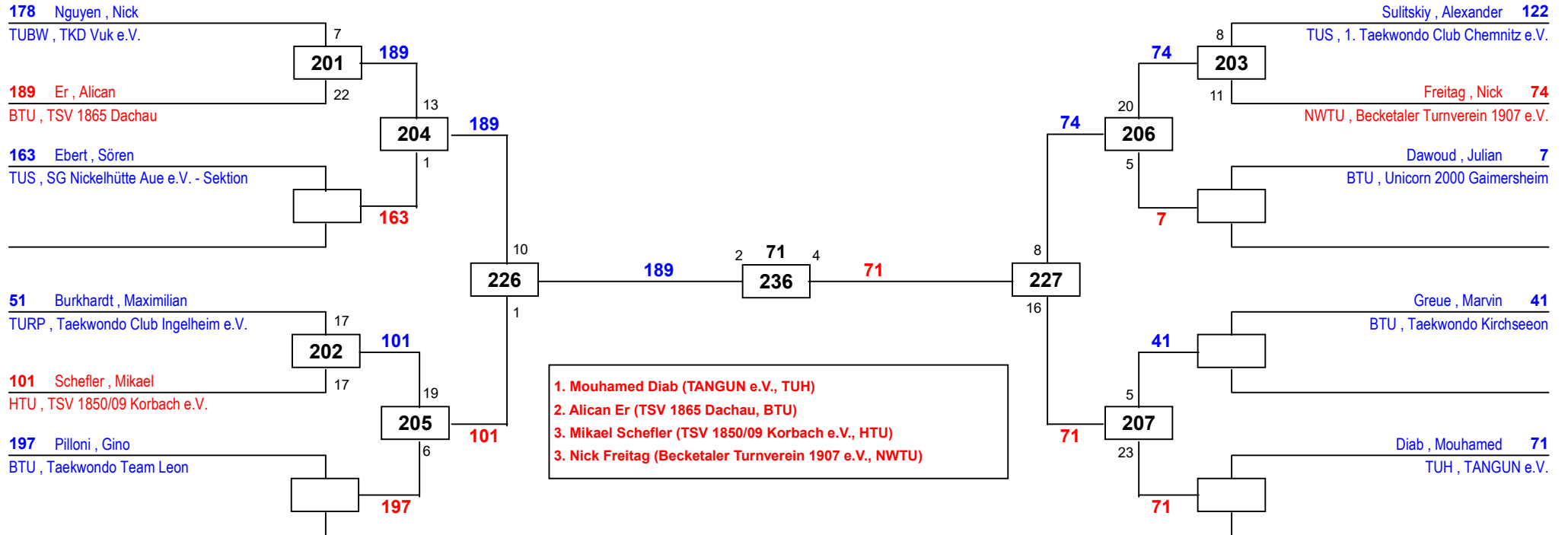



DEM Jugend A 2017

am 05.02.2017
J Am-78



Draw Sheet

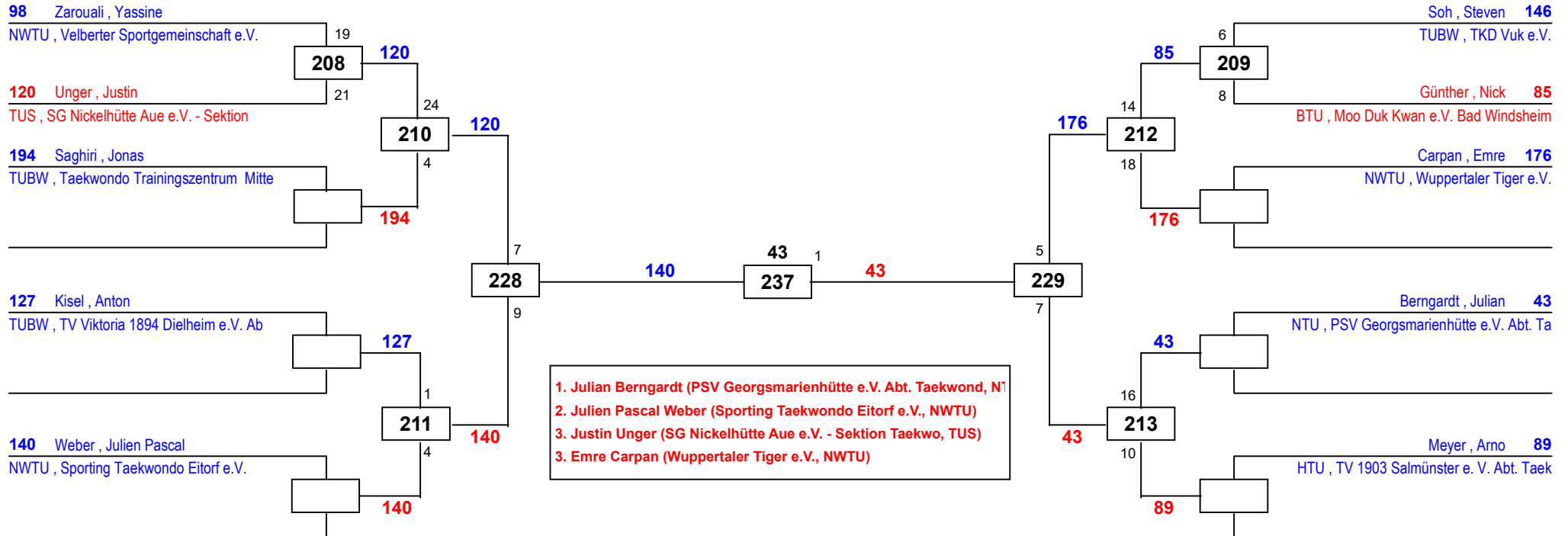



DEM Jugend A 2017

am 05.02.2017
J Aw-44



Draw Sheet

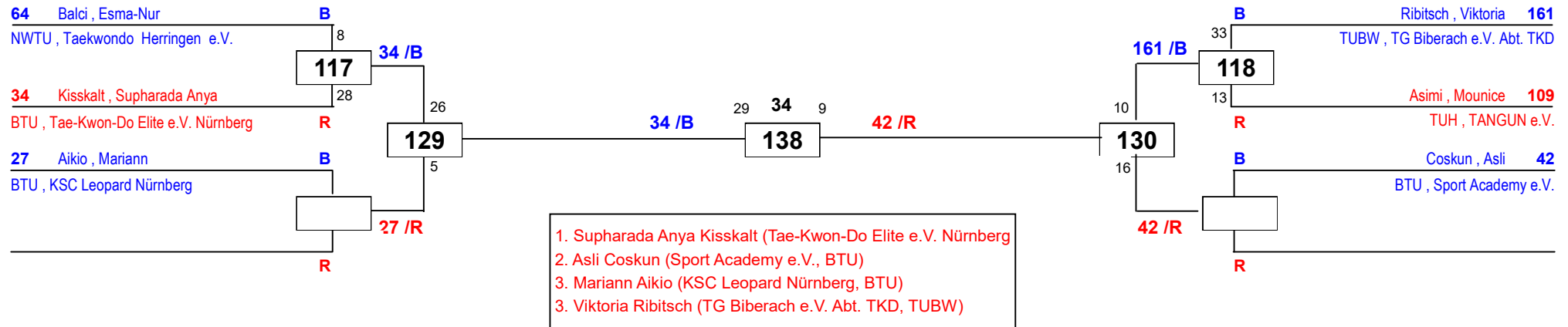



DEM Jugend A 2017

am 05.02.2017
J Aw-46



Draw Sheet

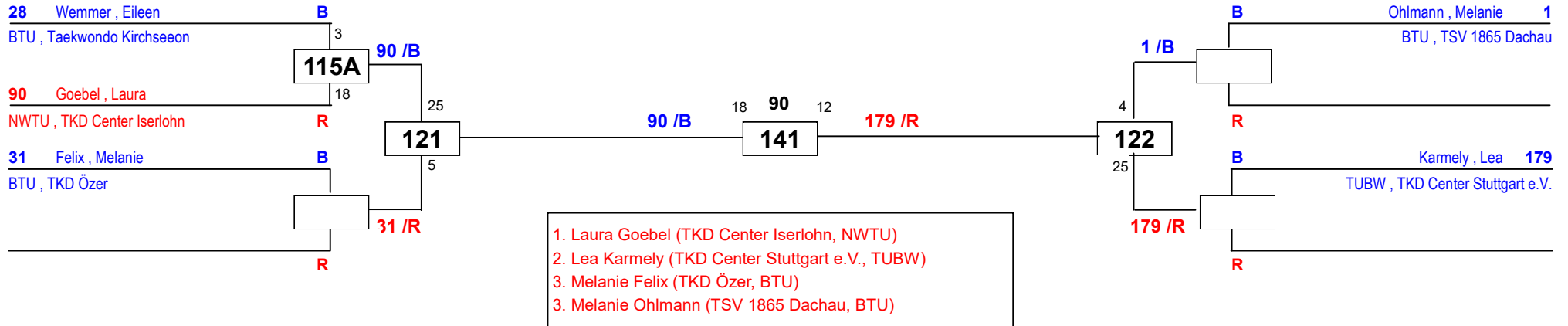



DEM Jugend A 2017

am 05.02.2017

J Aw-49



Draw Sheet

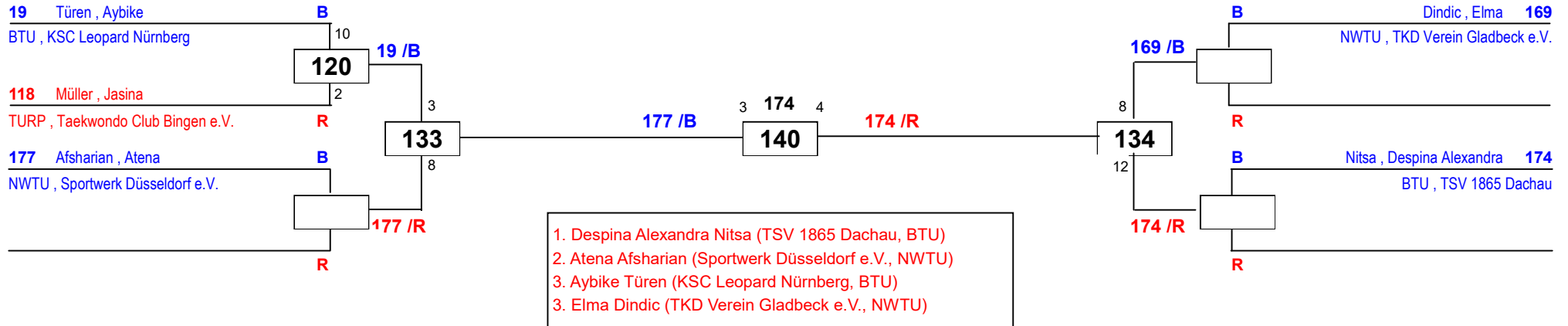



DEM Jugend A 2017

am 05.02.2017

J Aw-52



Draw Sheet

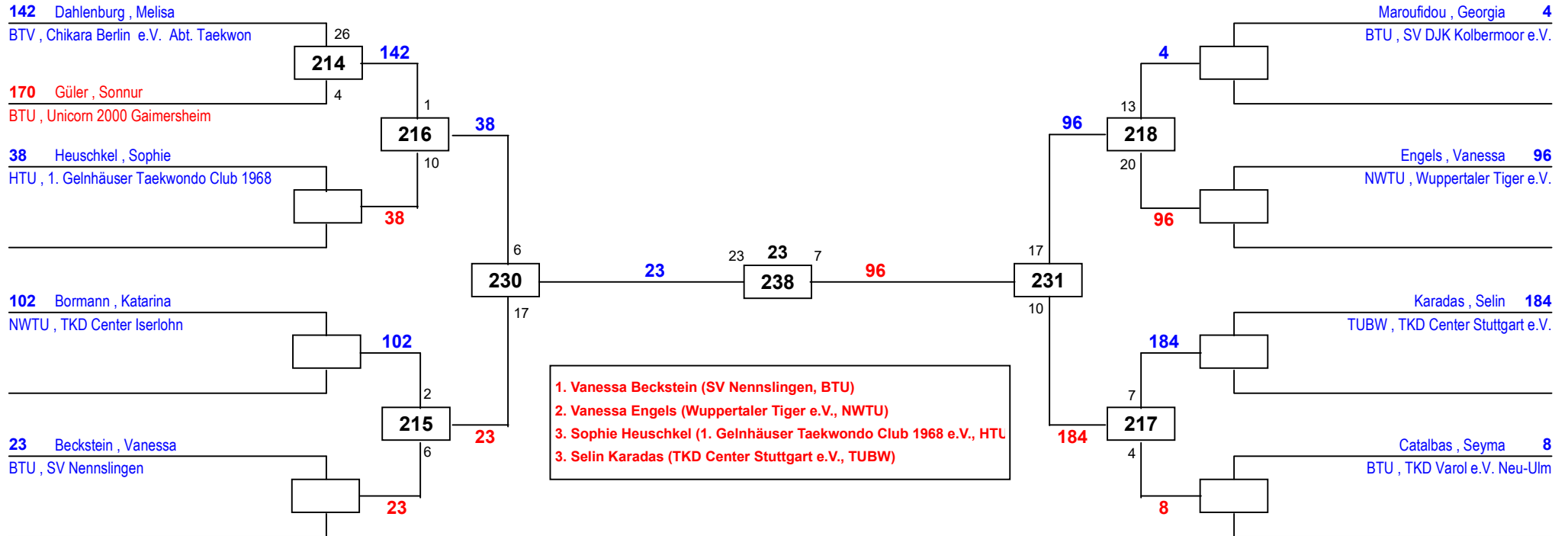



DEM Jugend A 2017

am 05.02.2017

J Aw-55



Draw Sheet

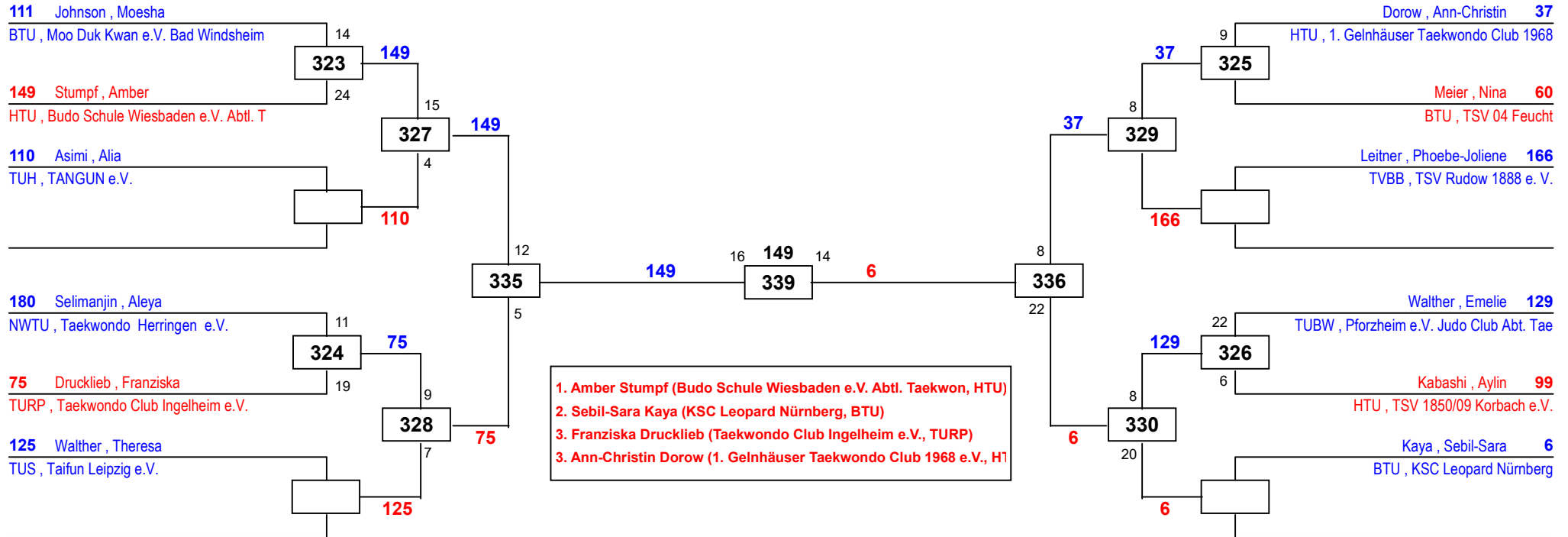



DEM Jugend A 2017

am 05.02.2017

J Aw-59



Draw Sheet

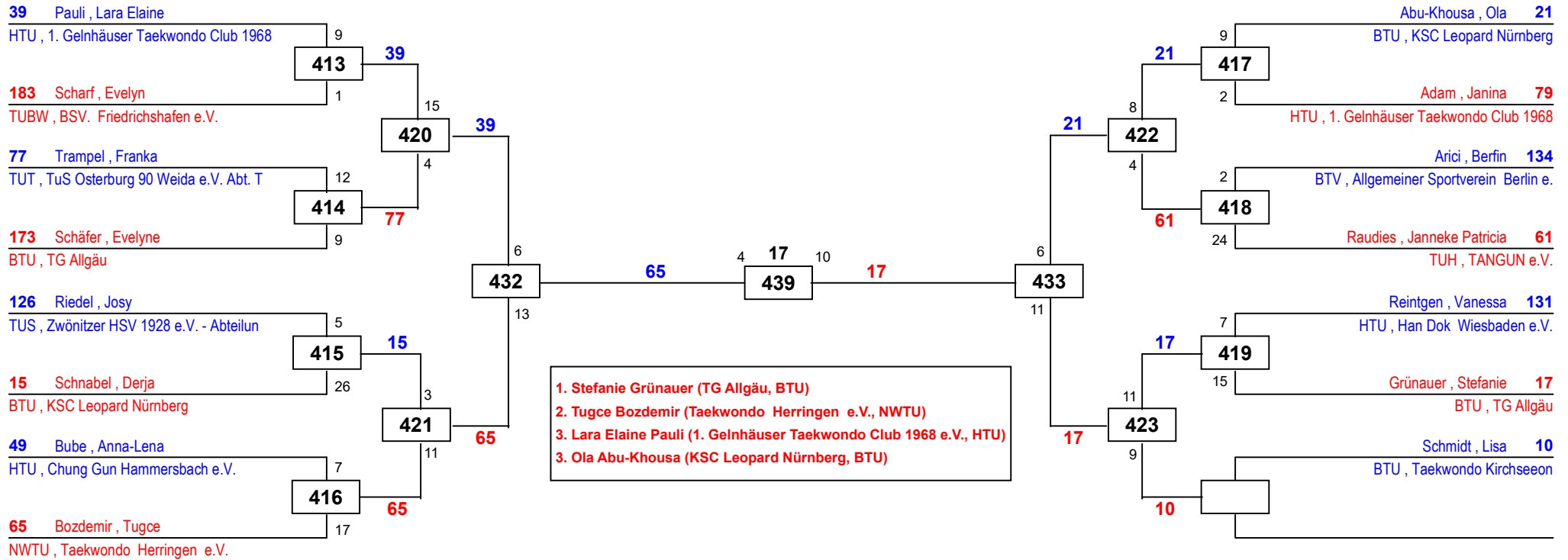



DEM Jugend A 2017

am 05.02.2017

J Aw-68



Draw Sheet

